

NCCG-xxx

**Gigabit-Ethernet-Flächenkamera
NCCG-xxx-Serie Monochrom / Farbe**

*Gigabit Ethernet area scan camera
NCCG-xxx series monochrome / color*

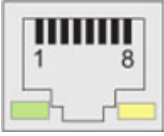
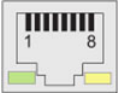

Technische Beschreibung / *Specification*

Chip / Sensor	Unterschiedliche Sensorgrößen / <i>Different sensor size</i> CMOS Progressive Scan / <i>CMOS Progressive Scan</i>																																	
Auflösung / Resolution	Unterschiedliche Auflösungen / <i>Different sensor resolutions</i> Siehe Übersichtstabelle / <i>see overview</i>																																	
Pixelgröße / Pixel size	Unterschiedliche Pixelgrößen / <i>Different pixel sizes</i> Siehe Übersichtstabelle / <i>see overview</i>																																	
Chipgröße / Scan area	Unterschiedliche Chipgrößen / <i>Different scan areas</i> Siehe Übersichtstabelle / <i>see overview</i>																																	
Objektivanschluss / Lens mount	C-Mount																																	
Bildwechselfrequenz / Frame rate	Unterschiedliche Bildwechselfrequenzen / <i>Different frame rates</i> Siehe Übersichtstabelle / <i>see overview</i>																																	
Farbmodelle / Color Models	Farbe und monochrom / <i>Color and monochrome</i> Siehe Übersichtstabelle / <i>see overview</i>																																	
Spannungsversorgung / Voltage feed	<ul style="list-style-type: none"> • via Power and Process Interface (extern / <i>external</i>) • via Data Interface (PoE) 																																	
Datenschnittstelle / Data Interface	RJ45-Buchse (8P8C Modularbuchse), verschraubbar / <i>RJ45 female connector (8P8C modular jack), screw lock type</i> Gigabit-Ethernet-Anschluss mit PoE: Daten und Steuerung / <i>Gigabit Ethernet connection: data and control interface</i> Gigabit Ethernet Transfer Rate / <i>transfer rate</i> : 1000 Mbits/sec Fast Ethernet Transfer Rate / <i>transfer rate</i> : 100 Mbit/sec Pin Belegung / <i>Pin assignment</i> :																																	
		<table border="1"> <tbody> <tr> <td>1</td> <td>green/white</td> <td>MX1+</td> <td>(negative / positive V_{port})</td> </tr> <tr> <td>2</td> <td>green</td> <td>MX1-</td> <td>(negative / positive V_{port})</td> </tr> <tr> <td>3</td> <td>orange/white</td> <td>MX2+</td> <td>(positive / negative V_{port})</td> </tr> <tr> <td>4</td> <td>blue</td> <td>MX3+</td> <td></td> </tr> <tr> <td>5</td> <td>blue/white</td> <td>MX3-</td> <td></td> </tr> <tr> <td>6</td> <td>orange</td> <td>MX2-</td> <td>(positive / negative V_{port})</td> </tr> <tr> <td>7</td> <td>brown/white</td> <td>MX4+</td> <td></td> </tr> <tr> <td>8</td> <td>brown</td> <td>MX4-</td> <td></td> </tr> </tbody> </table>	1	green/white	MX1+	(negative / positive V_{port})	2	green	MX1-	(negative / positive V_{port})	3	orange/white	MX2+	(positive / negative V_{port})	4	blue	MX3+		5	blue/white	MX3-		6	orange	MX2-	(positive / negative V_{port})	7	brown/white	MX4+		8	brown	MX4-	
1	green/white	MX1+	(negative / positive V_{port})																															
2	green	MX1-	(negative / positive V_{port})																															
3	orange/white	MX2+	(positive / negative V_{port})																															
4	blue	MX3+																																
5	blue/white	MX3-																																
6	orange	MX2-	(positive / negative V_{port})																															
7	brown/white	MX4+																																
8	brown	MX4-																																
LED Signalisierung / LED signalling	Grün blinkend / <i>green flash</i> Grün / <i>green</i> Gelb / <i>yellow</i> Gelb blinkend / <i>yellow flash</i>	RX aktiv / <i>active</i> Link Ein / <i>On</i> Fehler / <i>error</i> TX aktiv / <i>active</i>																																
																																		

**Prozessschnittstelle /
Process Interface**

M8-Stecker, A-codiert, 8-polig / *M8 male connector, A-coded, 8 pole*
 Spannungsversorgung, Trigger, Blitz / *voltage feed, trigger, flash*

Pin Belegung / Pin assignment:

1	GPIO (Line2)	white	5	Power VCC OUT1	grey
2	Power V _{CC}	brown	6	OUT1 (Line3)	pink
3	IN1 (Line0)	green	7	GND (Power, GPIO)	blue
4	GND IN1	yellow	8	GPIO (Line1)	red

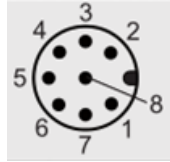

**Spannungsversorgung /
Voltage feed**

Power over Ethernet

Über / *via* Data Interface (Power over Ethernet IEEE 802.3af, PoE)
 Class 0 Gerät / *device*
 Spannung / *voltage* VCC: 36...57 VDC
 Strom / *current* I: Unterschiedliche Ströme / *different current values*

Externe Spannungsversorgung / Power Supply (ext.)

Über / *via* Process Interface (extern / *external*)
 Spannung / *voltage* VCC: 12...24 VDC ± 20%
 Strom / *current* I: Unterschiedliche Ströme / *different current values*

siehe Übersicht / *see overview*

Digital Input

(Trigger / *Trigger*)

Optokoppler / *optocoupler*

$U_{IN(low)} = 0,0 \dots 4,5$ VDC
 $U_{IN(high)} = 11 \dots 30$ VDC
 $I_{IN} = 3,0 \dots 10,0$ mA
 min. impulse length (t_{min}): 2 μ s

Digital Output

(Flash)

Optokoppler / *optocoupler*

$U_{EXT} = 5 \dots 30$ VDC, 24 VDC typical
 $I_{OUT} = \text{max. } 50$ mA
 $t_{ON} = \text{typ. } 3 \mu$ s $t_{OFF} = \text{typ. } 40 \mu$ s

Gehäuse / housing

Zinkdruckguss, Chrom-Nickel-beschichtet, IP40 (mit montierter Optik und GigE-Kabel) / *zinc die cast, nickel-chrome-plated, IP40 (with mounted lens and GigE cable)*

Abmessungen / Dimensions

Gehäuse/housing ohne/without Stecker/connector :
 29 mm x 29 mm x 55,5 mm (±0,35mm)
 Gehäuse/housing einschließlich/including Stecker/connector :
 29 mm x 29 mm x 64,4 mm (±0,35mm)

Gewicht / Weight

120 g

**Lagerungstemperatur /
Storage Temperature**

-10°C...+70°C

**Betriebstemperatur /
Operating temperature**

+5°C...+65°C @ T = Messpunkt / *measurement point*
 +5°C...+75°C @ internem Temperatursensor / *internal temperature sensor*
 Bei einer Umgebungstemperatur oberhalb 30°C sind Kühlungsmaßnahmen erforderlich / *Ambient temperature above 30°C requires cooling measures*

Feuchtigkeit / Humidity





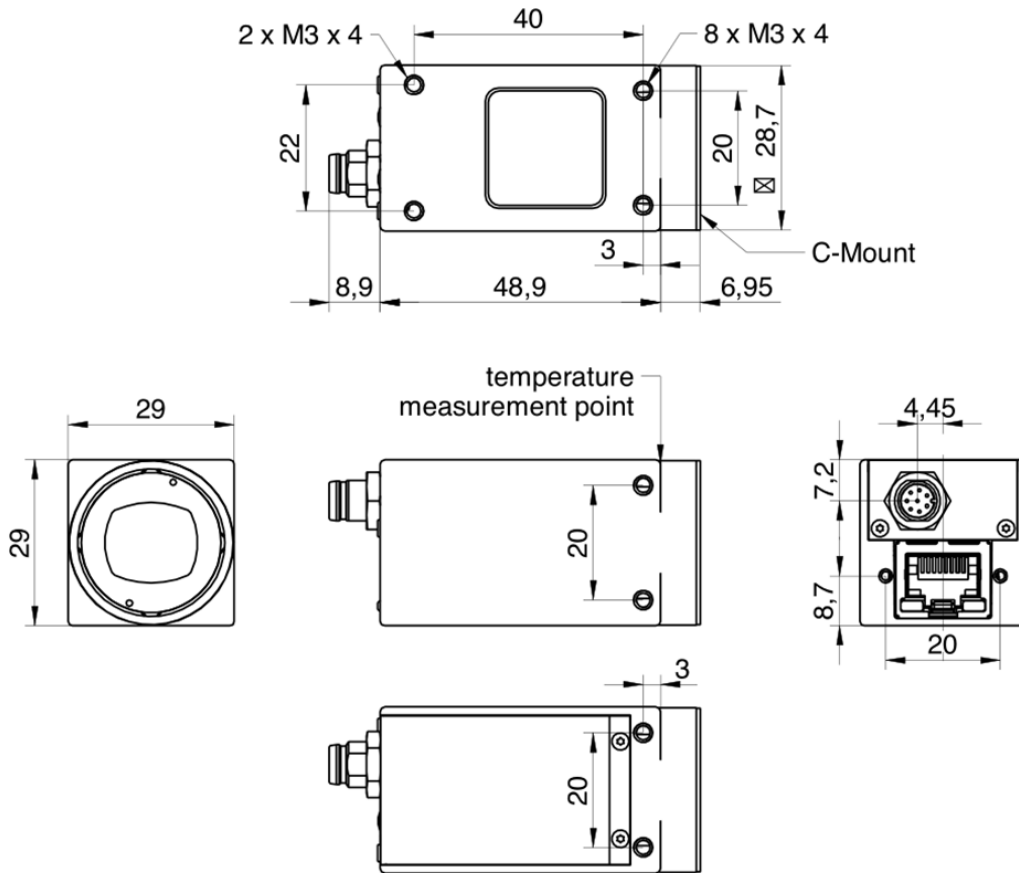

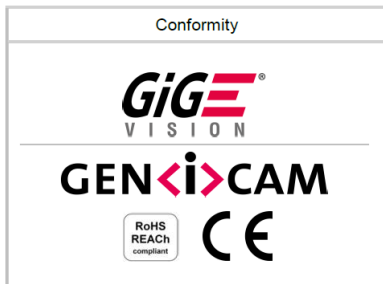
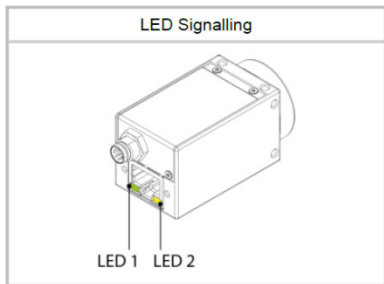
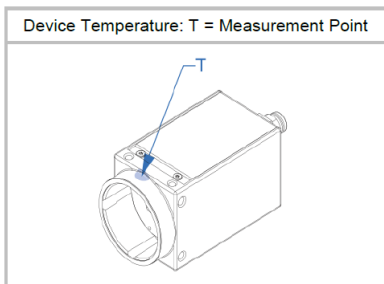

10%...90% nicht kondensierend / *non-condensing*





Technische Zeichnung / *Technical drawing*



Zusätzliche Abbildungen / *Additional images*



Variantenübersicht / Variants overview																
	NCCG-13M		NCCG-13C		NCCG-23M		NCCG-23C		NCCG-32M		NCCG-32C		NCCG-51M		NCCG-51C	
Chip / Sensor	1/2" progressive scan CMOS				1/1.2" progressive scan CMOS				1/1.8" progressive scan CMOS				2/3" progressive scan CMOS			
Shutter / <i>Shutter</i>	global				global				global				global			
Größe / <i>Scan area</i>	6,14 mm x 4,92 mm				11,25 mm x 7,03 mm				7,06 mm x 5,30 mm				8,45 mm x 7,06 mm			
Pixelgröße / <i>Pixel size</i>	4,8 µm x 4,8 µm				5,86 µm x 5,86 µm				3,45 µm x 3,45 µm				3,45 µm x 3,45 µm			
																
Auflösung / Resolution	1280 x 1024 pixels				1920 x 1200 pixels				2048 x 1536 pixels				2448 x 2048 pixels			
Bildwechselfrequenz / Frame rate	94 fps (Full Frame) 145 fps (Binning)				53 fps (Full Frame) 81 fps (Binning)				39 fps (Full Frame) 55 fps (Binning)				23 fps (Full Frame) 35 fps (Binning)			
Belichtungszeit / Exposure time	20 µs ... 1 s				35 µs ... 60 s				50 µs ... 60 s				1 µs ... 60 s			
Verstärkungsfaktor / Gain	0...12 dB				0...48 dB				0...48 dB				0...48 dB			
Pixelformat / Pixel formats	Mono 8 / 10		Bayer RG 8 / 10, Mono 8 / 10, RGB8, BGR8		Mono 8 / 10 / 12 / 12 Packed		Bayer RG 8 / 10 / 12 / 12 Packed, Mono 8 / 10 / 12 / 12 Packed, RGB8, BGR8		Mono 8 / 10 / 12 / 12 Packed		Bayer RG 8 / 10, Mono 8 / 10, RGB8, BGR8		Mono 8 / 10 / 12 / 12 Packed		Bayer RG 8 / 10 / 12 / 12 Packed, Mono 8 / 10 / 12 / 12 Packed, RGB8, BGR8	
Partial Scan	✓				✓				✓				✓			
Binning 2x2, 2x1, 1x2	✓				✓				✓				✓			
Farbmodelle / Color models	Mono		RGB, Mono		Mono		RGB, Mono		Mono		RGB, Mono		Mono		RGB, Mono	
Farbanpassungen / Color processing and adjustment	-		✓		-		✓		-		✓		-		✓	
Elektrische Daten / Electrical data	Extern / external PoE				U: 12...24 VDC U: 36...57 VDC				U: 12...24 VDC U: 36...57 VDC				U: 12...24 VDC U: 36...57 VDC			
Leistungsaufnahme / Power consumption	approx. 2,6 W @12 VDC and 94 fps 3,2 W @ 48VDC (PoE) and 94 fps				approx. 2,5 W @12 VDC and 53,5 fps 2,8 W @ 48VDC (PoE) and 53,5 fps				approx. 2,6 W @12 VDC and 39,5 fps 3,2 W @ 48VDC (PoE) and 39,5 fps				approx. 2,9 W @12 VDC and 23,5 fps 3,1 W @ 48VDC (PoE) and 23,5 fps			
External Trigger	U _{IN(low)} : 0,0 ... 4,5 VDC, U _{IN(high)} : 11 ... 30 VDC, min. impulse length: 2,0 µs															
Flash-Output	U _{EXT} : 5 ... 30 V DC, I _{OUT} : max. 50 mA															

Variantenübersicht / Variants overview							
	NCCG-53M	NCCG-53C	NCCG-124M	NCCG-124C			
Chip / Sensor Shutter / <i>Shutter</i> Größe / <i>Scan area</i> Pixelgröße / <i>Pixel size</i>	1" progressive scan CMOS global 12,44 mm x 9,83 mm 4,8 µm x 4,8 µm  		1.1" progressive scan CMOS global 14,13 mm x 10,35 mm 3,45 µm x 3,45 µm  				
Auflösung / Resolution	2592 x 2048 pixels		4096 x 3000 pixels				
Bildwechselfrequenz / Frame rate	23,5 fps (Full Frame) 28 fps (Binning)		10 fps (Full Frame) 15 fps (Binning)				
Belichtungszeit / Exposure time	20 µs ... 1 s		60 µs ... 6 s				
Verstärkungsfaktor / Gain	0...12 dB		0...48 dB				
Pixelformat / Pixel formats	Mono 8 / 10	Bayer RG 8 / 10, Mono 8 / 10, RGB8, BGR8	Mono 8 / 10	Bayer RG 8 / 10 / 12 / 12 Packed, Mono 8 / 10 / 12 / 12 Packed, RGB8, BGR8			
Partial Scan	✓		✓				
Binning 2x2, 2x1, 1x2	✓		✓				
Farbmodelle / Color models	Mono	RGB, Mono	Mono	RGB, Mono			
Farbanpassungen / Color processing and adjustment	-	✓	-	✓			
Elektrische Daten / Electrical data Extern / external PoE	U: 12...24 VDC U: 36...57 VDC		U: 12...24 VDC U: 36...57 VDC				
Leistungsaufnahme / Power consumption	approx. 2,8 W @12 VDC and 23,5 fps 3,7 W @ 48VDC (PoE) and 23,5 fps		approx. 3,1 W @12 VDC and 10 fps 3,5 W @ 48VDC (PoE) and 10 fps				
External Trigger	U _{IN(low)} : 0,0 ... 4,5 VDC, U _{IN(high)} : 11 ... 30 VDC, min. impulse length: 2,0 µs						
Flash-Output	U _{EXT} : 5 ... 30 V DC, I _{OUT} : max. 50 mA						